

A Syntactic Analysis of Agreement in Gîtigania

Lilian Gacheri Ntarangwi¹, Muriungi Kinyua Peter², Muriungi Colomba Kaburi³

Chuka University, Kenya

¹kiambil@yahoo.com, ²muriungip@yahoo.com, ³colombak@yahoo.com

Abstract: *In this paper we provide a syntactic explanation of agreement in Gîtigania using the Minimalist Theory as proposed by Chomsky (2002). We demonstrate that C-command as a relation of agreement can be used to explain the syntax of agreement in Gîtigania. We show that in the syntax of Gîtigania agreement, the agreement morphemes in syntactic trees C-command the noun phrases that they agree with. In subject-verb agreement, the agreement morpheme attached to the verb C-commands the subject noun phrase. For verb-object agreement, the morpheme for agreement attached to the verb C-commands the object noun phrase whereas for noun-modifier agreement, the agreement morphemes attached to the respective modifiers C-command the noun phrases that they modify. We also show that in Gîtigania, the visibility of a Goal to a Probe is restricted by locality. The Probe only agrees with the Goal which is closest to it in its C-command domain.*

1. INTRODUCTION

This article examines the syntax of Gîtigania agreement from a minimalist perspective. The article is organized as follows. In section 2, I give the analysis of agreement where I introduce the Specifier- Head and the C-command approaches to agreement. Next, I introduce Gîtigania as a dialect of Kimeru language after which I give its noun classes. In section 3, I provide a syntactic explanation of agreement in Gîtigania using the C-command approach to agreement. Specifically, I analyze the syntax of the subject-verb, verb-object and noun-modifier agreement. Section 4 gives the findings of this study while in section 5 a conclusion based on this study is made.

2. AGREEMENT

Agreement is considered as the modification of the form of one element to match the properties of another element. Its rules mark a constituent X to agree with another constituent Y with respect to such categories as number and person. It concerns the marking of various morph syntactic properties of a head such as person and number features henceforth phi features on the dependents of that head. For instance, within an NP, determiners and attributive adjectives often share the number and person features of the head noun thus agreement is achieved.

According to Kroeger (2006), agreement is a general term used to describe a situation in which the grammatical features of a noun or a noun phrase determine the morphological shape of a word that is syntactically related to the noun or noun phrase in some way. The word that determines the features of the whole phrase is called the head. The other non-head elements of the phrase that carry the properties of the head are referred to as the dependents of that head (Kroeger, 2006). It therefore means that agreement involves feature sharing where a non-dependent (the head) shares a feature with the dependents. Just like any other language, heads in Gîtigania phrases share features with their dependents.

2.1. Gîtigania Dialect

Gîtigania is one of the dialects of Kimeru language spoken in Meru County which is in Kenya. It serves as the first language in the current Tigania East and Tigania West sub-counties. As a dialect of Kimeru language, Gîtigania therefore belongs to the Bantu language family. Though many people use Gîtigania as their first language, there is limited research in the language.

Bantu languages constitute a large percentage of the world's languages. Michael (2010) notes that 7.5 per cent of the world's languages are Bantu. Nevertheless, these languages have not been well researched. In fact, Michael (2010) says that Bantu languages are woefully under-researched.

A Syntactic Analysis of Agreement in Gítigania

One of the most defining characteristics of Bantu languages is the rich noun class systems. Noun class membership is important for marking of agreement. Words in some parts of speech such as verbs and adjectives undergo changes to achieve agreement with the respective nouns that they are used with. This is mostly in regard to number and class. Nouns in particular are organized into classes which trigger agreement. This is as exemplified using Kiswahili in (1).

- (1) Kibaki a li shinda
 Kibaki 1 Agr 1 PAST win
 ‘Kibaki won’ (Deen 2006: 226)

As shown in (1), a noun from class 1 requires that the subsequent verb carries an agreement marker (a) for noun class 1 for the sentence to be grammatical. The prefix that appears on a noun determines its particular class.

2.1.1. Gítigania Noun Classes

All Bantu languages are known for their noun classes which are numbered systematically. Singular and plural noun classes are paired. Mostly, singular noun classes are odd numbered while their plural counterparts are even numbered. This system however does not apply to Gítigania noun classes that are above class 8. These classes are as shown in table 1. They are borrowed from Mukuthuria (2004) with a few adjustments made to them. The table shows all the 17 noun classes in Gítigania. The prefixes used with the nouns in the respective classes are shown. Examples of words are given for each of the 17 noun classes.

Table1. *Gítigania Noun Classes*

Class Number	Prefix	Examples
1	Mu-/Mw-	Muntu, Mwana
2	A-	Antu, Ana
3	Mũ-	Mũtĩ, Mũringa
4	Mĩ-	Mĩtĩ, Mĩringa
5	-ĩ/Ri	Īga, Riĩtwa
6	Ma-	Maiga, Mariĩtwa
7	Kĩ-/Gĩ-	Kĩoro, Gĩtai
8	Ci-/I-	Cioro, Itai
9	N-	Nyungũ, Nyoni
10	N-	Ndego, Ndwito
11	Rũ-	Rwego, Rũrĩndĩ
12	Ka	KaanaKanyoni
13	Tũ-	Twana, Tũnyoni
14	Ũ-	Ũcũrũ, Ũtheru
15	Kũ-	KũrĩmaKũrwa
16	A-	Aa, Au
17	K-	Kwao, Kũraya

Adapted from Mukuthuria 2004 p. 188

2.2. Approaches to Agreement

In all languages, sentences are made up of words put together. There is no specific order in which words in a sentence are put together. Every sentence has a structure that specifies certain relationships that hold between its basic elements. Adger (2003) uses the term syntactic structure to refer to the building blocks in a sentence. When the right relationships are not expressed in a certain sentence in any language, native speakers know this and judge the sentence as unacceptable. It is therefore the work of syntacticians to show how the basic elements of a sentence interact and connect through agreement phenomena as all human languages whether living or dead have a syntactic structure including of course signed languages (Tallerman, 2005).

To determine the principles that guide agreement in any language, one needs to be guided by a particular approach. According to Zwart (2006), there are different approaches to agreement. These include the Specifier-Head and the Agree (C-command) relation.

2.2.1. Agreement as a Function of Specifier–Head Relation

The assumption made in a Specifier–Head relation is that agreement is only licensed if a functional head and the DP with which it agrees stand in a Specifier- Head relation. Buell (2005) argues that agreement between a lexical subject and the subject marker is the result of the Specifier-Head relation in which they stand. This is exemplified in (2).

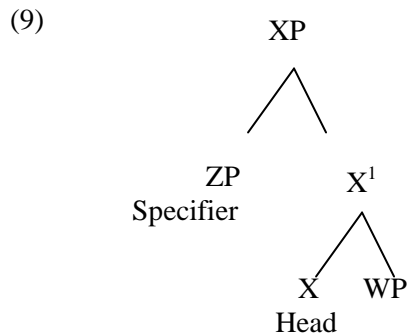

In the figure, ZP and X are in agreement since they are in a Spec–Head relation. Secondly, in such a configuration, all sentences are assumed to have subjects DPs which originate in the projection of the verb (Sportiche, 1988; McCloskey, 1991). When the subject moves from the Specifier of VP to the specifier of TP, it creates a Specifier- Head configuration necessary for agreement. The DP moves to satisfy the Extended Projection Principle requirement and check case. The Extended Projection Principle henceforth EPP is the requirement that clauses must contain a noun phrase in the subject position. Nominative case on the subject DP can only be checked by a finite T. It is through movement that the NP subject moves to the (Spec, T) and agrees with the finite verb. This creates a Spec-Head relation hence there is agreement.

In other cases where there are agreement phrases, the subject occupies the specifier position of an agreement phrase (AgrP) and agrees with the Agr representing the person/number features associated with the verb as shown in (3).

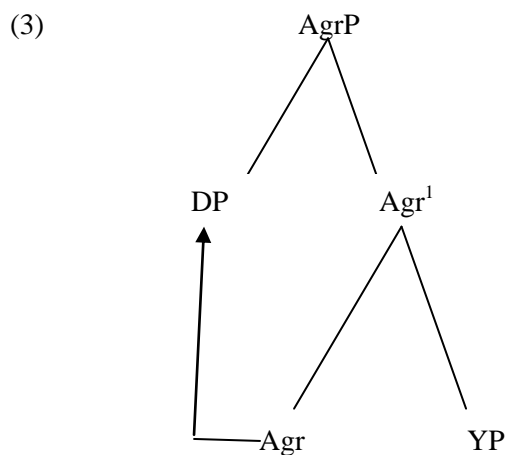

The Kiswahili sentence ‘Kibakialishinda.’ for example can be represented as shown in (4).

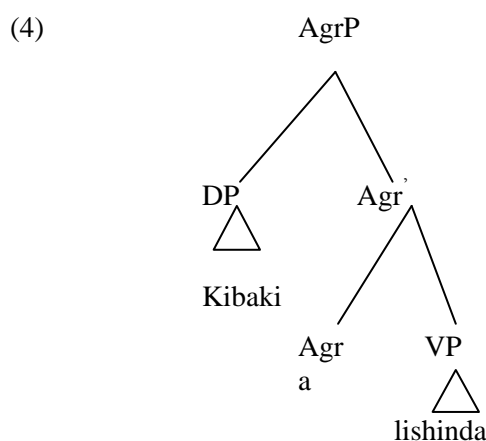

As the DP, ‘Kibaki’ occupies the specifier position. The agreement morpheme ‘a’ as the head shows the person/number features of the DP. The two stand in a Spec-Head relation hence there is agreement. However, there are cases where the Spec-Head relation is not sufficient to account for agreement. Some predicates require/allow a dummy/expletive subject, a subject with no semantic function (Borsley, 1991). The expletive is required for purely morphological reasons. It fills the subject prefix slot (Baker, 2003). In English for example, the subject position can be occupied by the expletive ‘there’ as exemplified in (5).

(5) There is a student playing in the field.

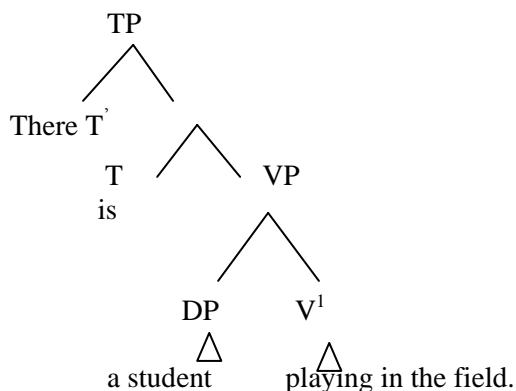

There is agreement between the head ‘is’ and the DP ‘a student’. The Spec-Head relation cannot account for such a relationship. However, in the later versions of the Minimalist Program, the theory of Spec-Head agreement has been abandoned in favor of agreement as a function of C-command.

2.2.2. Agreement as a Function of C-command

This approach states that for agreement to be successful, the elements that display it must be in a certain position with respect to the element that determines it. Chomsky (1998), who has not been challenged to date, proposes that the configurational relation relevant to agreement is the one between a head T (for tense) and the phrase it C-commands. A node X C-commands node Y if every node dominating X also dominates Y and neither X nor Y dominates the other. Chomsky (1998) argues that agreement is the result of the syntactic nodes; the Probe and the Goal. The Probe is the syntactic node associated with element that displays agreement. The Goal is the syntactic node associated with the element that determines agreement. The Probe must C-command the Goal in order to establish agreement. This is as shown in (6).

(6)

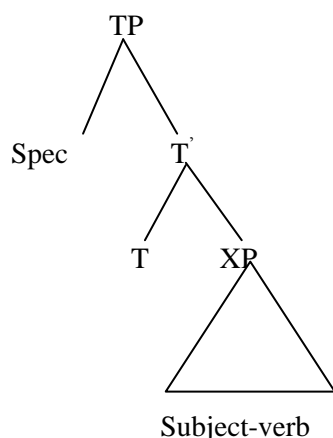

In the structure, T is the Probe and the subject is the Goal. This means that the subject originates in a position C-commanded by T. Movement to the Specifier position of TP is triggered by feature checking requirements and not agreement. In fact, movement is not a condition for agreement.

Chomsky (1995) proposes that items in an Agree relation, that is the Probe and the Goal must be in a C-command relation but the Goal must not move to the Specifier of the Probe’s projection. In other cases, a Goal like a subject can move to the Specifier TP to satisfy the EPP which is the requirement that clauses must contain an NP in the subject position. It is not Agree that forces this movement.

C-command can be symmetric or asymmetric. 'A' symmetrically C-commands 'B' if 'A' C-commands 'B' and 'B' C-commands 'A' as it happens between sister nodes. 'A' asymmetrically C-commands 'B' if 'A' C-commands 'B' but 'B' does not C-command 'A'. This is illustrated in (7).

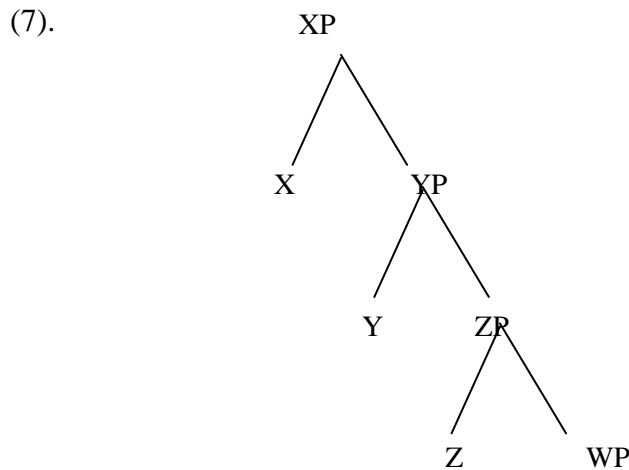

In the above syntactic tree, node 'X' C-commands 'YP' and all its sub-parts. 'X' symmetrically C-commands 'YP' but asymmetrically C-commands 'Y', 'ZP', 'Z' and 'WP'.

In Minimalist syntax, the relationship between the Probe and a Goal is asymmetric. There exist two types of features namely interpretable and uninterpretable features. Uninterpretable features need to be checked with an interpretable feature of a matching type. To find a matching feature, the Probe will search its C-command domain for a suitable Goal. The C-command domain of an element constitutes the elements which are dominated by the first node which dominates this element.

Though in his recent minimalist work Chomsky (2002) states that C-command requirement is the standard view on the syntactic configuration in which agreement is licensed, it is not the only condition on Agree. Chomsky also proposes matching, activeness and locality.

In matching, the features on the Goal should match the uninterpretable unvalued features on the Probe. Non- interpretable features enter the derivation unvalued, and therefore they must be valued in the course of derivation. Feature valuation involves feature sharing (Abels, 2012). A Probe with a non-interpretable feature searches for a Goal within its C-command domain. It (Probe) with a feature unvalued must find a compatible Goal with that same feature valued. If found the values are copied. If for instance A is valued for some feature F and if B agrees with A, the feature value for A (F) is copied into B.

Compatible features enter a match relation only if they have the potential to check one another. If the features require valuation, an agree relation obtains between them. In the Probe-Goal system, feature checking is a two-step procedure. In the first procedure, compatible features enter a match relation ensuring that they have the potential to check one another. In the second procedure, if the features involved require valuation, an agree relation obtains between them. Agree values the set of features in the match relation that are unvalued. For both the Probe and the Goal to be active, they should have uninterpretable features. The active Probe (by virtue of unvalued features) must find a compatible Goal with same feature valued for it to copy them.

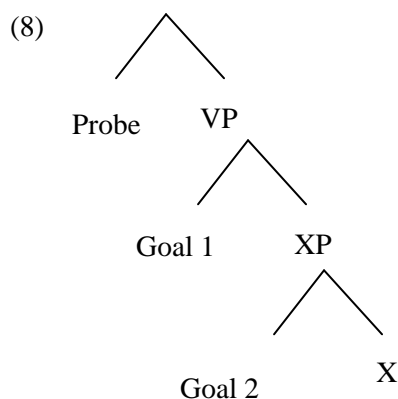

The span over which matching and activeness rules apply to elements in a particular structure is limited by locality. This refers to the proximity of elements in a linguistic structure. The locality condition requires that in a syntactic structure, the Probe displays the features of the matching Goal that is closest to it in its C-command domain. Therefore, the locality condition reduces to the closest C-command (Riedel, 2009). It requires that in a syntactic structure, no potential Goal 1 matching P which contains the Goal 2 to be agreed with. This is as shown in (8).

In the structure, Goal 1 is inside the domain of Goal 2. This makes Goal 1 the closest C-commanding Goal. Therefore, Agree with Goal 2 is ruled out. The current study treats agreement as a function of C-command as it takes care of all syntactic relations explained through Specifier-Head relation and even those that it (Specifier-Head relation) does not take care of.

The term C-command is the shortened form of constituent command. It was introduced by Tanya Reinhart in 1976. Informally, a node C-commands its sisters and all the daughters and granddaughters and great-granddaughters of its sister. Formally, node A C-commands node B if every node dominating A also dominates B and neither A nor B dominates the other. This is exemplified in (9).

(9).

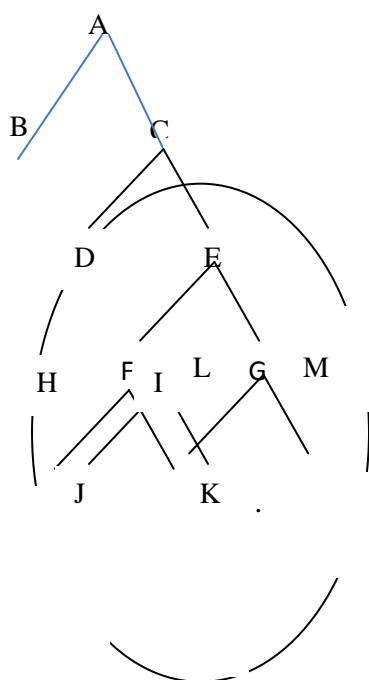

In the diagram, node D C-commands all the nodes in the circle. It doesn't C-command any other. This means that D C-commands its sister (E) and all the nodes dominated by its sister (F, G, H, I, J, K, L, M). As a relation therefore, C-command holds between sisters, aunts and nieces. It never holds between cousins or between mother and daughter.

3. A SYNTACTIC ANALYSIS OF AGREEMENT IN GÍTIGANIA

Grammars have certain defining properties. A fundamental property for the grammar of every language is that it is compositional. This means that sentences are made of clauses and phrases which in turn are made up of smaller clauses, phrases or words, (Fosold, 2012)

Syntax is the component of grammar which determines how words are combined together to form phrases and sentences. This means that it is the study of the way in which phrases and sentences are structured out of words. It looks at the structures of sentences and the grammatical operations by which its component words are combined together to form the overall sentence structure.

Traditionally, agreement was said to involve a spec-head relationship a. However, in cases where there is a dummy subject, the spec-head relation is not sufficient to account for agreement. This can nevertheless be explained using Chomsky's (2001) idea of Agree. This is the C-command relation which states that for Agree to be successful, the elements that display it must be in a certain position with respect to the element that determines it. As noted earlier, Chomsky argues that Agreement is the result of the syntactic nodes; the Probe and the Goal with the Probe being the syntactic node associated with the element that displays Agreement while the Goal is the syntactic node associated

with the element that determines Agreement. The Probe must C-command the Goal in order to establish Agreement. Consider the English example in (10):

(10) Maria was playing soccer

The structure for (10) will be as in (11).

(11)

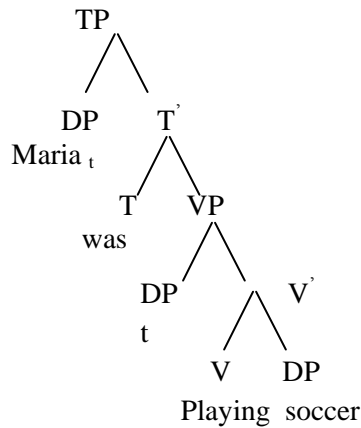

The element ‘t’ in (11) stands for trace. It is a conventional symbol that represents the original position of the moved element. Subscripts like _t indicate that the elements that they mark are identical. In (11), the Goal ‘subject’ is contained in the VP. The C-command requirement is met since the probe ‘was’ C-commands the Goal ‘Maria’.

I restricted myself to the C-command requirement of agreement to explain the syntax of subject-verb, verb-object and noun-modifier agreement patterns. The agreement morphemes were treated as Probes and noun phrases as the Goals in their respective constructions. This was represented on tree diagrams. Consider the Gĩtigania sentence (12):

(12) Mwana a kũ rea irio.
 Child 1 SM1 PERF eat food
 ‘The child has eaten food.’

In a tree diagram, the structure of (12) will be as shown in (13).

(13)

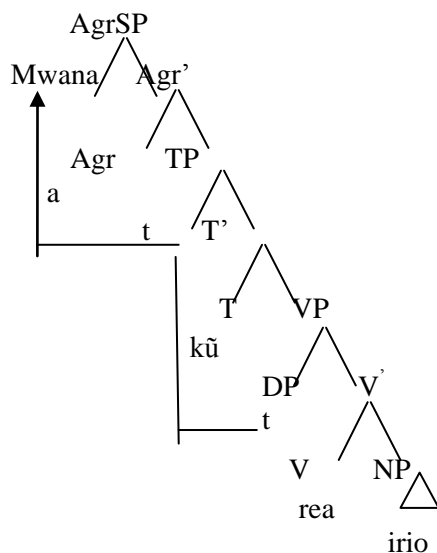

There is agreement between the SM ‘a’ and the DP ‘Mwana’ since the SM ‘a’ as the probe ‘a’ C-commands the Goal ‘Mwana.’

As observed in the diagram, subjects originate internally within the VP (Sportiche, 1988; McCloskey1991). The arguments of verbs are subsequently raised into the specifier position within

TP with the relevant movement operation being triggered by an EPP feature carried by T. The EPP as explained earlier is a syntactic requirement requiring T to have a specifier which is a noun or a pronoun expression. The VP internal subject hypothesis allows us to explain why subjects are believed to start within the VP as exemplified in (14).

- (14) a. Someone is knocking at the door.
- b. There is someone knocking at the door.

In (14 a) the NP ‘someone’ occupies the subject position whereas in (14 b), the expletive there occupies the subject position otherwise occupied by DPs. An expletive is a meaningless element put in some position to fulfill a grammatical requirement. In English, the expletive occupies the subject position at the specifier of the TP. Sentences (14 a) and (14 b) assume the structures as shown in (15 a) and (15 b) respectively.

(15 a)

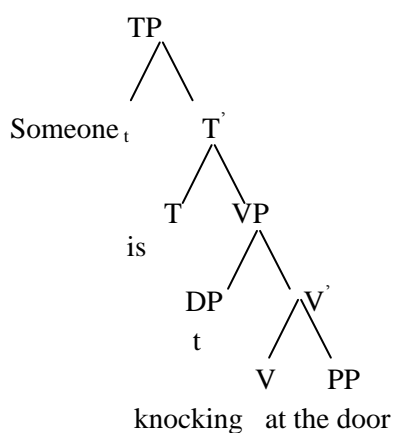

(15b)

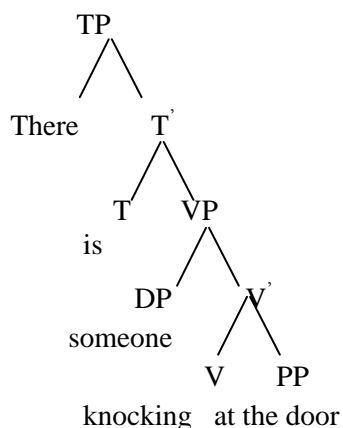

(15 a) and (15 b) have the same basic structure. In both examples, someone as the subject starts in the specifier of VP. In (15 a) it moves to the subject position while in (15 b), it cannot move to that position because this position is occupied by the expletive and thus must stay in its original position inside the VP.

The analysis of (15 b) shows that the sentence contains two subjects. ‘There’ is the subject of ‘is’ at the spec TP while ‘someone’ is the semantic subject of the verb knocking. The pronoun ‘there’ satisfies the syntactic requirement of the EPP feature on T requiring T to have a specifier which is a noun or a pronoun expression and could be said to be the syntactic subject of the sentence.

Current research on grammar assumes that phrases are constructed bottom-up. Words are drawn from a lexicon – a dictionary stored in people’s brains rather than in a book and merged into structures one-by-one (Fosold, 2012). Considering this fact, sentence (15 b) would be derived as follows using a simplified structure, that is, without showing the internal structure of every expression.

The preposition phrase ‘at the door’ merges with the verb ‘knocking’ to form the V bar (incomplete verb expression) ‘knocking at the door.’ The resulting V bar is then merged with the subject of ‘knocking’ which is the DP ‘someone’ to form the VP ‘someone knocking at the door’ which is then

merged with the present tense (T) auxiliary ‘is’ forming the T bar ‘is someone knocking at the door.’ Considering the already explained syntactic requirement that every T constituent has an EPP feature requiring it to have a noun or a pronoun expression as its specifier, this can be satisfied in (78 b) by merging the expletive ‘there’ with the T bar ‘is someone knocking at the door.’ The resulting TP is then merged with a null declarative complementiser forming the CP ‘There is someone knocking at the door.’

Just as it is the case in the derivation of (15 b) to derive (15 a), the preposition phrase ‘at the door’ merges with the verb ‘knocking’ to form the V bar ‘knocking at the door’ which is then merged with the subject of knocking namely the DP ‘someone’ to form the VP ‘someone knocking at the door’. Next the auxiliary ‘is’ merges with the VP ‘someone knocking at the door.’ The T ‘is’ has an EPP feature requiring it to project to a structural subject/specifier. This requirement of T to have a subject with person/number properties is satisfied by moving the subject ‘someone’ from its original position in spec V into the new position in spec T in the manner shown in (16).

(16)

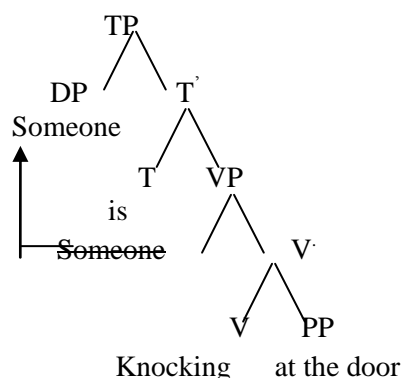

The arrow in (16) indicates the direction of movement. Just as it happens in other languages like English, subjects in Gítigania are VP internal. This means that in syntactic structures, the subject NP is expected to be lower than the agreeing SM which is attached to the verb. This means that the SM acts as the Probe and the subject DP is in its C-command domain. Consider (17) which is a Gítigania sentence:

- (17). Mūkūrū ka ura nyama
 Man1 SM1 FUT buy meat
 ‘The man will buy meat.

The structure of (17) will be as shown in (18).

(18)

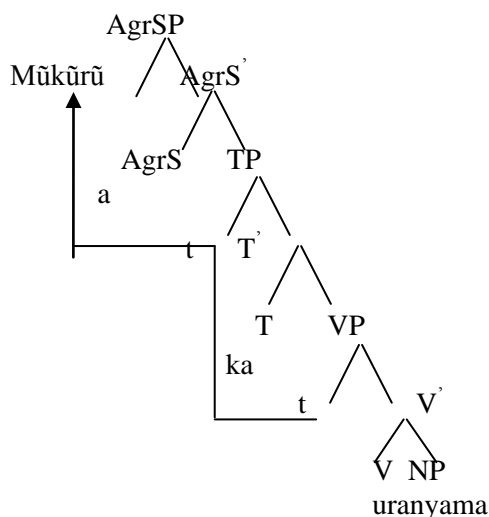

To derive (17), the noun phrase ‘nyama’ which means meat merges with the verb ‘ura’ which means buy to form the v bar ‘uranyama’. The resulting V bar is then merged with the subject of the verb ‘ura’ which is ‘mūkūrū’ meaning man to form the VP ‘mūkūrūuranyama’. The VP is then merged with the future tense ‘ka’ to form the T bar ‘kamūkūrūuranyama’. T requires a subject with

person/number properties. To achieve this, the subject ‘mūkūrū’ is moved from its original position to the specifier TP. The resulting TP is then merged with the subject agreement phrase ‘a’ to form the subject agreement phrase bar (AgrS[̄]) ‘a mūkūrūkauranyama’. Since this AgrS[̄] has an EPP feature it requires the subject to move to the specifier of the subject agreement phrase. This results in the sentence ‘Mūkūrūkauranyama.’ It is observed in (18) that the subject of the verb starts in the specifier of VP.

3.1. The Syntax of Subject Marking in Gîtigania

This article analyzes the syntax of agreement patterns in respect to the Minimalism program by Noam Chomsky whose key tenet is the Probe–Goal relationship of the elements in a syntactic structure. Agreement exists when the probe T C-commands the Goal (subject) in the specifier of VP. When the subject moves to the specifier of TP, it does not mean that it is not C-commanded by T as the starting position of the subject is VP internally as earlier on explained.

In Gîtigania sentences, there is subject–verb agreement. The prefix attached to the verb marks agreement. In syntactic structures, it is expected therefore that as a marker of agreement, the SM shows features corresponding to the noun class of the given subject. This satisfies the Minimalist C-command requirement on agreement since the SM as the Probe C-commands the subject noun phrase as the Goal.

Consider (19) which is a Gîtigania sentence:

- (19) Mwana a kū rea.
 Child 1 SM1 PERF eat
 ‘The child has eaten.’

In the sentence, the SM ‘a’ is the agreement marker for class 1. In a tree diagram, the representation will be as shown in (20).

(20)

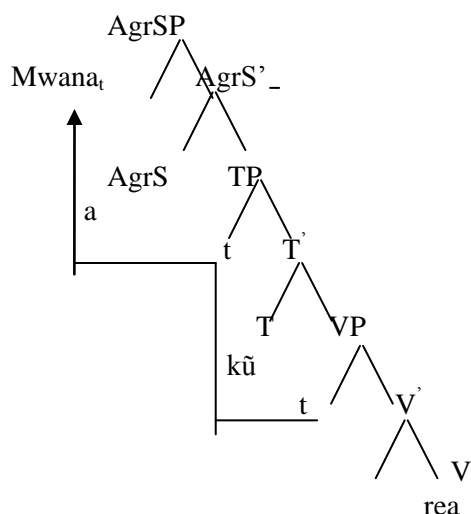

In the structure, the arrow shows the direction of movement. The subscript ‘t’ means ‘trace of’. It shows where the subject begins. As the Goal in the sentence, the subject begins in the VP. It then moves to the spec TP after which it moves to the specifier of the agreement phrase. As an agreement marker, the SM ‘a’ acts as the Probe. The subject noun phrase with which it agrees is within its C-command domain. This means that according to Minimalism, there is agreement between the subject and the verb since the subject is within the C-command domain of the SM as the Probe. It therefore means that in Gîtigania, the SM acts as the Probe while the subject NP acts as the Goal. This is as it happens in other languages like English as earlier explained. Also, according to Minimalist syntax, the other requirements of agree apart from C-command are matching, activeness and locality. In (20), there is matching since the uninterpretable features on the Probe are checked by the interpretable features on the Goal which is the subject DP as the third person singular. The Probe ‘a’, acquires the third person singular henceforth 3PS features from the Goal, hence there is matching. The locality requirement is also met since there is no other Goal within the C-command domain of the Probe (a)

that intervenes agreement between the Probe ‘a’ and the Goal ‘mwana. Therefore, ‘mwana’ as the Goal is closest to the Probe ‘a’ hence there is agreement.

In other cases, nouns can be coordinated and still agree with the verb in Gîtigania as shown in (21).

(21)

- a. Akūrũ na aritwa ba ke ya.
 Man2 and students2 SM2 FUT come
 ‘A man and students will come.’
- b. Mîî na îũgũ bi ke ndua.
 Trees4 and beehive8 SM8 FUT sell
 ‘The (trees) and a beehive will be sold.’
- c. Mũrîthi amwe na ng’ambe a ũraîrw e nîngatũnyi
 Shepherd1 together with cow9 SM1 kill PAST by lion9
 ‘The shepherd together with the cow was killed by the lion’
- d. Rwego kana nyumbaî ka îthua
 Fence11 or house9 SM9 FUT burn
 ‘The fence or the house will be burnt’

When Gîtigania nouns from the same noun class are conjoined, the agreement marker prefixed to the verb corresponds to the plural class of the conjoints as shown in (21 a). If the noun phrases that are non-human are coordinated, the agreement marker used is the default one from class 8 as shown in (21 b) while in coordination of a human and a non-human conjunct, the agreement marker corresponds to the class of the human conjunct as shown in (21 c). In cases of choice, the SM corresponds to the second conjunct as (21 d) shows. The respective syntactic trees for the Gîtigania sentences in (21) will be as in (22).

- (21) a. Akūrũ na aritwa ba ke ya.
 Men2 and students2 SM2 FUT come
 ‘Men and students will come’.

In a tree diagram, (21 a) will be as shown in (22 a).

(22 a)

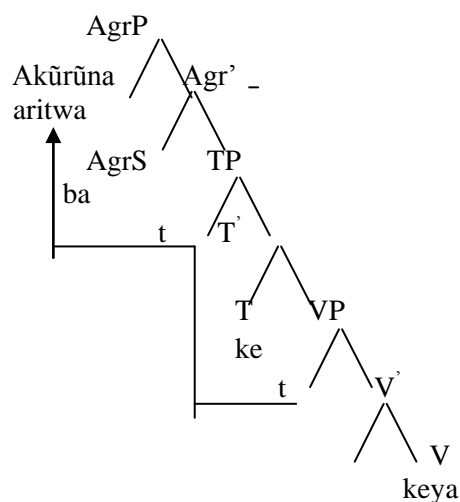

In (22 a), the SM ‘ba’ as the Probe C-commands the coordinated subject ‘akūrũnaaritwa’ as the Goal. It (SM) corresponds to NC 2 which is the class of each of the coordinated subjects. Therefore there is agreement between the subject and the SM as the Minimalist C-command requirement is met. There is also matching since both the Probe ‘ba’ and the Goal ‘akūrũnaaritwa’ bear the third person plural features henceforth 3PL. The locality condition is also met as the Probe and the Goal are not intervened. Consider (21 b):

(21 b). Mîfî na îûgû bi ke ndua
 Trees3 and beehive5 SM5 FUT sell(APPLI)
 ‘Trees and the beehive will be sold.’

In a syntactic structure (21 b) will be as in (22 b).

(22 b)

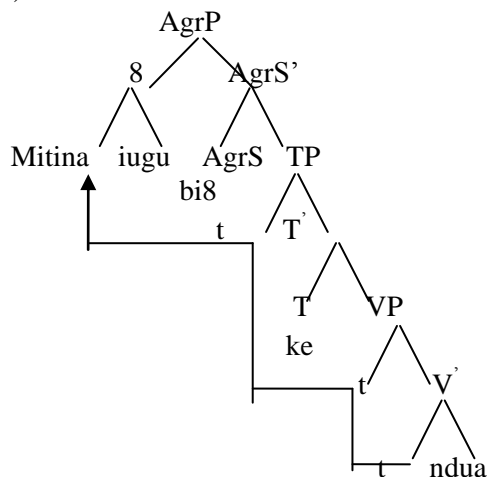

In case a Probe fails to agree with the features on the Goal, the derivation crashes. In (22 b), ‘bi’ as the Probe bears the features of noun class 8 which is not the class of any of the conjuncts. The derivation does not crash though. This is because when conjuncts belonging to different classes are coordinated, there is a mismatch and so they project to the default class 8 as shown below.

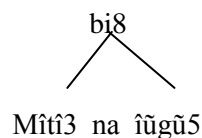

This compares to what happens in Sambia as explained by Riedel (2009). However, in Sambia, the default class 8 is acceptable even in coordination of non-human animates unlike in Gîtigania agreement where the default class is only permissible when coordinating inanimate noun phrases only. In tree diagrams, the projected default class 8 becomes the Goal which matches with the Probe ‘bi’ of class 8 hence there is agreement. In (22 b), the Probe ‘bi’ C-commands the subject NP ‘mîfînaîûgû’ hence syntactically, there is agreement between the two. Consider (21 c):

(21 c) Mûrîthi amwe na ng’ambe a ûraîrwe nî ngatûnyi
 Shepherd together with cow SM1 kill(APPLIC) by lion
 ‘The shepherd together with the cow were killed by the lion’

Syntactically, (21 c) will have the representation shown in (22 c).

(22 c)

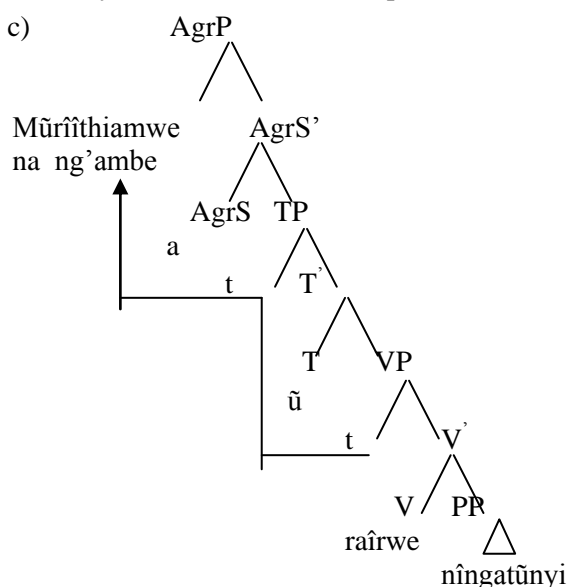

The Probe ‘a’ corresponds to the animate conjunct. The Probe C-commands the Goal which is the NP ‘Mūrîithi’. ‘Amwenang’ambe’, meaning ‘together with the cow’ shows that only the animate part of the noun phrase is given recognition as the Goal and is seen to agree with the Probe. This therefore means that when an animate is coordinated with an inanimate the conjuncts do not project to a default class. Consider (21 d) where the subject is made up of coordinated inanimate nouns using a conjunction of choice.

- (21d) Rwego kana nyumbai ka îthua
 Fence11 or houses10 SM10 FUT burn
 ‘The fence or houses will be burnt’

The syntactic structure for (21 d) will be as in (22 d).

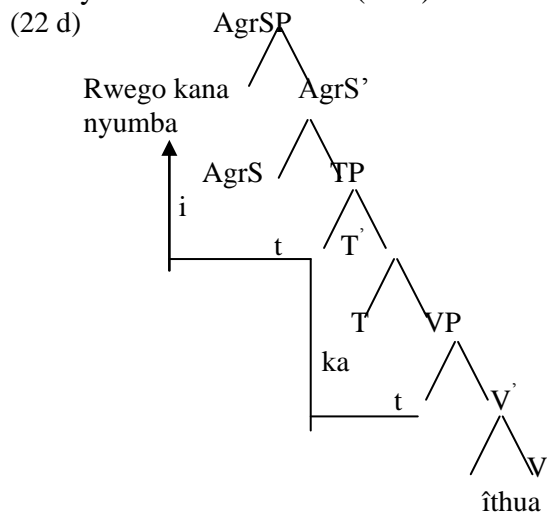

When Gîtigania conjuncts are coordinated using a conjunction of choice, the subject agreement marker used corresponds to the conjunct next to the conjunction. As an agreement morpheme, ‘i’ corresponds to the noun class of the second conjunct ‘10’. It acts as the Probe and C-commands Goal hence meeting the Minimalism condition of Agree. The two match since they both bear the 3PL features.

From the syntactic structures in (22), the SMs act as the Probes while the subject noun phrases are the Goals in their respective C-command domains. So, the Minimalist C-command requirement of Agree is met hence there is agreement.

3.2. The Syntax of Verb-Object Agreement in Gîtigania

There are languages which exhibit verb-object agreement while others do not. Consider the English sentence in (23).

- (23). Jane will buy a car.

In the sentence, the verb ‘buy’ is transitive. It takes the object ‘a car’. Verb-object marking is absent. Therefore, there is no verb-object agreement. In other cases, there is overt object marking as realized in most Bantu languages. In such languages, the object marker prefixed to the verb displays agreement which is determined by the object noun phrase. Therefore, in syntactic structures, the object marker acts as the Probe and the object noun phrase as the Goal. In this thesis, I argue that Gîtigania has syntactic object agreement. This section illustrates that Gîtigania object marking patterns can be derived using the Minimalism Agree mechanism.

3.2.1. Gîtigania Object Agreement with Single Objects

Many languages that allow object agreement only do so with a single object (Riedel, 2009). I treat the Gîtigania object markers in this article as heads since they are the agreement morphemes based on the element that they agree with. The basic projection form will be the AgrP where the morpheme functioning as the head will agree with the object. I will name this as AgroP to mean object agreement phrase. Consider the Gîtigania sentence in (24).

- (24). Juma a ka mũ ringa.
 Juma 1 SM1 FUT OM1 hit
 ‘Juma will hit him.’

The derivation of (24) is as shown in (25).

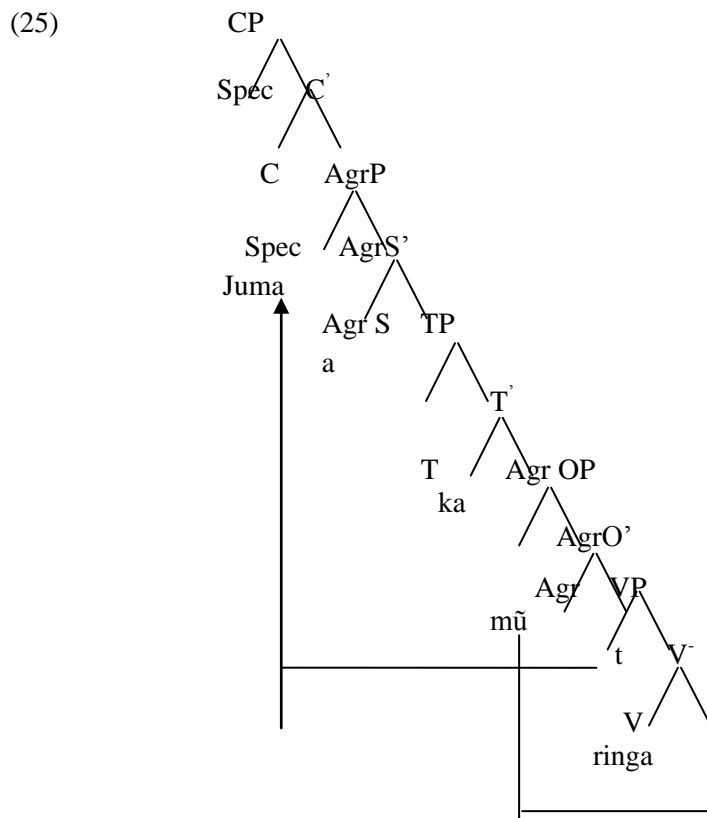

In the sentence the OM agrees with the non-overt object noun phrase which is in the VP hence C-commanded by the OM. There is matching as the non-overt object as the Goal inherently carries the 3PS features which are realized in ‘mũ’ as the object marker which is the Probe.

In (25) agreement with both the subject and the object is possible as the two are checked by different heads. Though the object agreement is with a Probe higher than V, the subject NP does not block the closest C-command requirement between the object and the object agreement morpheme. This is because the subject moves before agreement takes place and then it is no longer a possible intervener an opinion held by Riedel (2009). Other Gîtigania sentences have objects but lack object marking as shown in (26).

- (26) Juster a ã rîre ngarî na metha
 Juster1 SM1 PAST buy car and table
 ‘Juster bought a car and a table’

In the sentence, there is no overt object marking. Its structure will be as shown in (27).

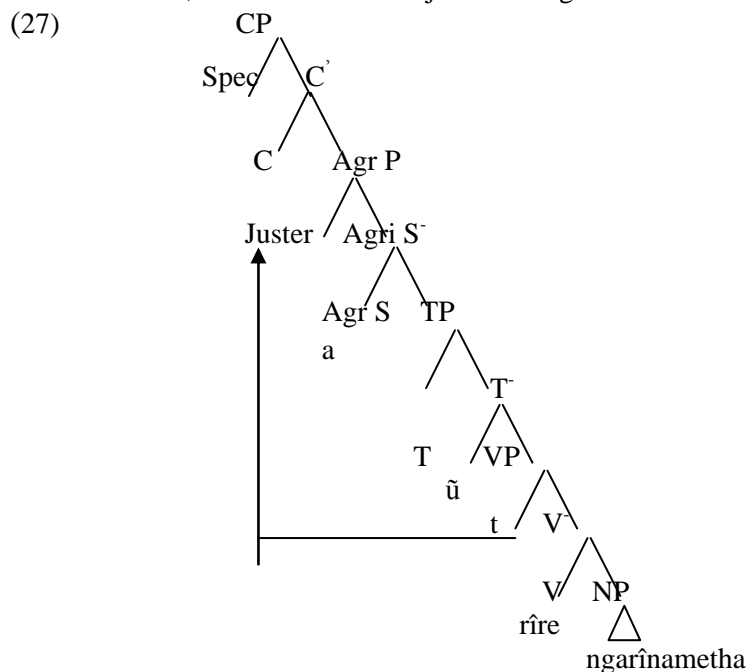

The syntactic structure lacks an AgrO head since there is no object marking. This is unlike (25) which has an AgrO head as it has got overt object marking.

3.2.2. Syntax of Double Object Constructions in Gâtigania

There are times when verbs in sentences take two objects: the direct and the indirect object. Consider (28):

(28) a. Joan gave Rose a ring
 S V IDO DO

In the sentence, the direct object is ‘the ring’ while the indirect object is ‘Rose’. The syntactic structure for (28 a) is as shown in (28 b).

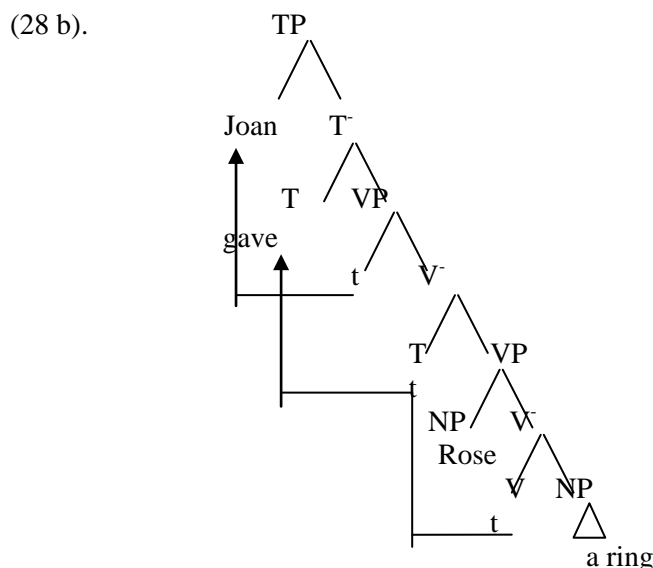

As shown in the structure, the indirect object is in the specifier position of VP. This means that the indirect object will be closer to any probe located above VP and asymmetrically C-command, the direct object. In (28 b), the indirect object (Rose) C-commands the direct object (a ring). The IDO is local to the Probe. The two are in the same clause and therefore the the IDO is bound by the Probe. The theory of syntactic restrictions that governs the distribution of different types of NPs is called the Binding Theory (Chomsky, 1981). For an NP to bind another, the two need to be in a certain structural relationship. An NP that gives meaning to another noun in a sentence is called an antecedent. In syntax, subscript letters are used to indicate that two NPs refer to the same entity. Two NPs that get the same index are said to be co-indexed. The crucial relationship between co-indexed NPs is C-command. If an NP is co-indexed with another, and the two are within the same binding domain, then the NP higher in a syntactic structure binds the other. In fact, C-command is a condition of binding. Each nominal has a domain, which is its clause (Fosold, 2012). Even a moved element is said to bind its trace. A binds B if A C-commands B and B and A are co-indexed (Batlin, 2003). This is illustrated in (29). In (29 a), the reciprocal ‘each other’ refers to the subject ‘the teachers’ while in (29 b) the reciprocal refers to the object of the sentence ‘the kids’ Consider (29):

- (29) a. Which portraits of each other did the teachers think that the kids would like best?
- b. The teachers showed the kids portraits of each other.

In (29 a), the reciprocal ‘each other’ can refer to either ‘the teachers’ or ‘the kids’ but given that it (the reciprocal) is in the same clause with the subject ‘the teachers’, it (the subject) is taken as the antecedent of the reciprocal by virtue of being in its binding domain. In (29 b) the antecedent is taken to be ‘the kids’ since the reciprocal is in its binding domain. Given that English does not allow overt object marking, there are no agreement morphemes to mark agreement with the object.

In Bantu languages like Kiswahili, object marking is optional and when it exists in double object constructions, object marking is only possible for one object in a clause (Riedel, 2009). Consider (30):

(30) Walimuwa li m pa mwanafunzi zawadi
 Teacher2 SM2 PAST OM1 give student1 present
 (The) teachers gave the student a present.

In the sentence, there is an object marker for class 1 which is the class of the indirect object. (31) shows the syntactic structure that corresponds to (30).

(31).

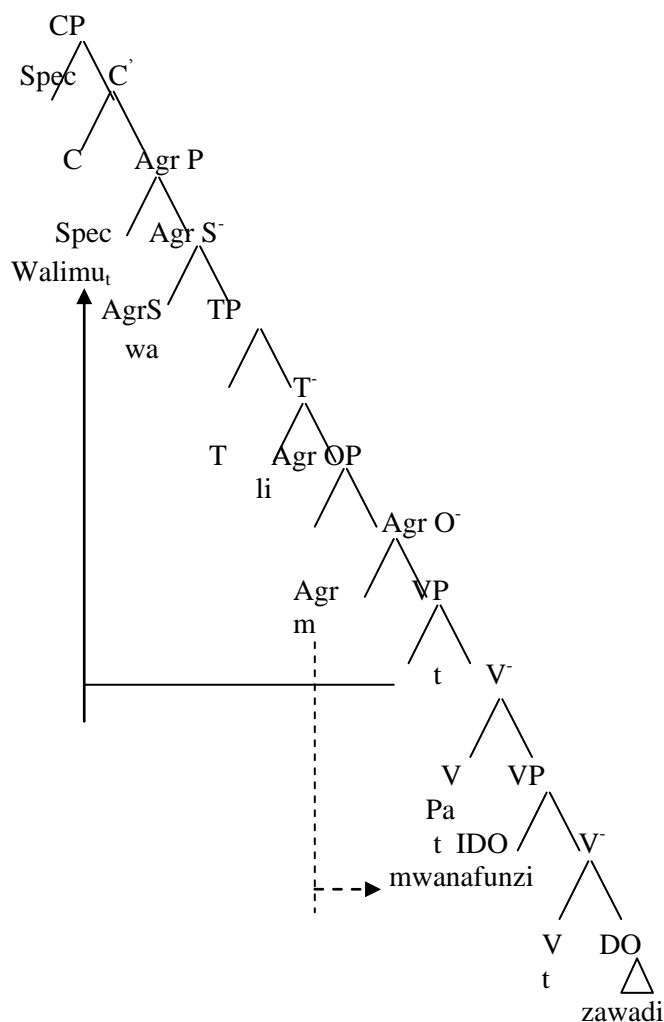

In the structure, the arrow shows subject movement from spec VP while the dotted line shows agreement with the indirect object. It is the IDO that is local to the Probe which is the OM ‘m’. The checked features of the IDO block checking of the DO. It is therefore impossible for there to be agreement with the direct object.

Gîtigania also allows double object constructions. Object marking is with the indirect object as exemplified in (32).

- (32). Jane a ka ba nenkera akūrū mbeca
 Jane SM1 FUT OM2 give man2 money
 ‘Jane will give money to the men’

(33) Shows the syntactic structure of (32).

In (33) the arrows show movement while the dotted lines show agreement.

Gîtigania allows double object constructions. The OM when used corresponds to the indirect object. In (33) the OM ‘ba’ appears higher than the agreeing object NP ‘akūrū’. As the Probe, the OM ‘ba’ C-commands the object NP ‘akūrū’. Though the subject ‘Jane’ appears higher than the object NP ‘akūrū’ in the syntactic structure, it does not block agreement with it since the subject in the spec VP moves before agreement takes place. This shows that agreement in Gîtigania fits into the Minimalist ideas about agreement.

Just as it happens in Kiswahili and Haya, indirect objects in Gîtigania C-command the direct ones but the vice-versa is not possible. Gîtigania does not allow two object markers in the same sentence. This is unlike some Bantu languages like Sambia. In other cases, the indirect object does not trigger

obligatory object marking in Gîtigania. This means that it is possible to have Gîtigania sentences with objects but no object marking. In fact, object marking is optional. The syntactic structure of such sentences lack AgrO heads. In Gîtigania sentences that are object marked, the subject marker precedes tense and the object marker follows the tense. In cases of double object constructions, the preferred word order is V, IDO, DO, with the object marking possible for one object in a clause. In Gîtigania, the visibility of a Goal to a Probe is restricted by locality. The Probe agrees with the object which is closest to it. Also, the phi features on nouns are interpretable. This means that the Probe searching for the person or number features will see them. This allows for the grammatical Gîtigania sentences with objects but no object markers.

(33).

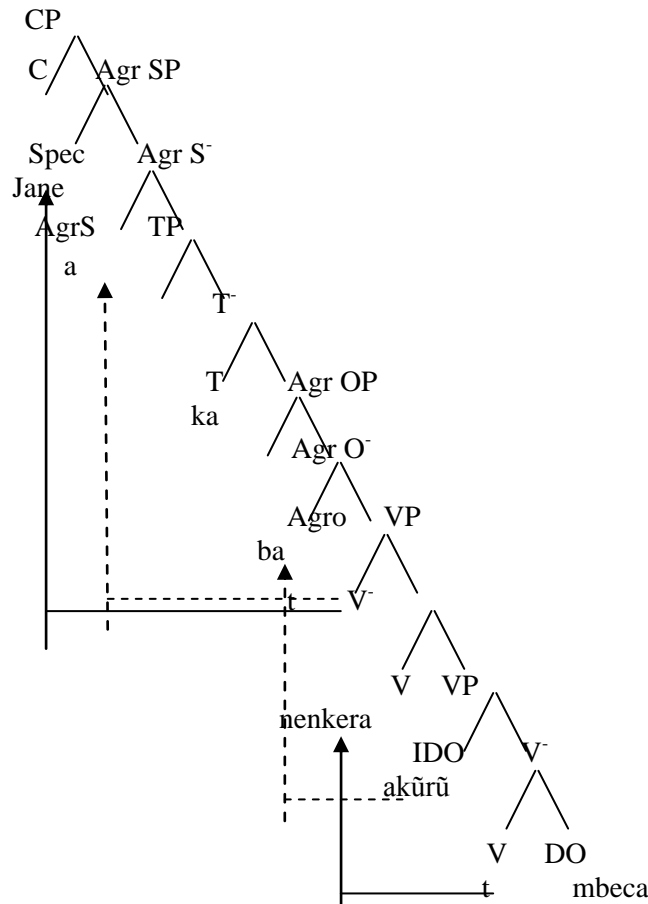

3.3. The Syntax of Noun Modifier Agreement in Gîtigania

Depending on individual languages, modifiers can either be post or pre-nominal. Consider the English example in (34):

(34). The white dress.

In (34) ‘white’ as an adjective modifies the noun phrase ‘dress.’ It is pre-nominal. English does not have any overt agreement. Therefore, there is no agreement morpheme in the sentence. The following structure in (35) corresponds to the phrase in (34):

(35)

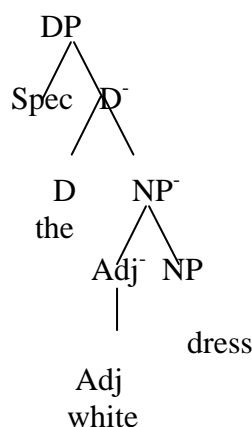

In the syntactic structure, there is no agreement morpheme since English does not have an overt agreement marker.

In Gîtigania, like in many other Bantu languages all modifiers follow and agree with the head noun as illustrated in the subsequent examples. The modifier carries the features of the NP it modifies in languages that exhibit Noun-modifier agreement. In the Minimalist idea of Agree, the agreement marker attached to the modifier is treated as the head. In a syntactic structure, the modifier is treated as the head and should C-command the NP it modifies. In this thesis, I have labeled the projection of the modifier ModP such that concerning the demonstrative, numeral and adjective modifiers used, I have worked with DemP, NumP and AdjP respectively. I have restricted myself to the three types of modifiers.

3.3.1. The Syntax of Gîtigania Demonstrative Modifiers

Bantuists argue that demonstrative modifiers in Bantu can either be pre-nominal or post-nominal. Some languages like Zulu allow any order (Dreu, 2005). In Gîtigania, demonstratives are post-nominal as earlier explained. Consider (36):

- (36). Mũtî yũ ù
 Tree DM3 this
 ‘This tree’

(36) Corresponds to the syntactic tree in (37). Consider (37):

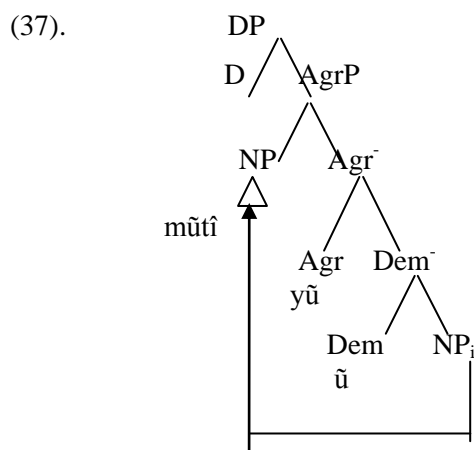

The arrow shows the direction of movement. An agreement morpheme of Noun class 3 which is the class of the noun being modified is attached to the demonstrative and it C-commands the NP. Therefore, there is agreement between the DM and the noun being modified.

3.3.2. The Syntax of Gîtigania Numeral Modifiers

In Gîtigania, a numeral as a modifier follows a noun. I have used NumP to mean the projection of a numeral. (38) is a Gîtigania example of an NP.

- (38). Ana ba thatũ
 Children2 NumM2 three
 ‘Three children’

In a syntactic tree, (38) will be as shown in (39).

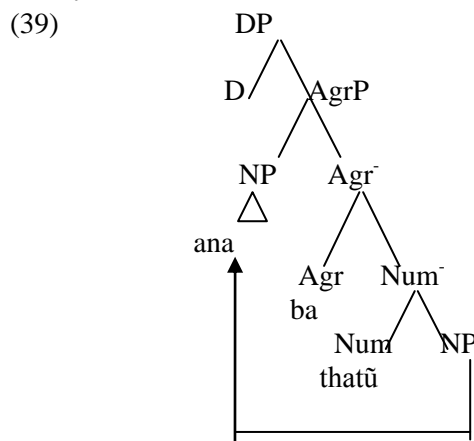

In the structure, the numeral agreement morpheme as the Probe C-commands the NP ‘ana’ as the Goal. The two carry the 3PL features hence there is matching. Therefore, there is agreement between the two.

3.3.3. *The Syntax of Gîtigania Adjective Modifiers*

In Gîtigania, there is noun-adjective concord. This is also exemplified in (40).

- (40). îrukî rî nene
 Monkey5 AdjM5 big
 ‘A big monkey’

Syntactically, (40) will be represented as shown in (41).

(41).

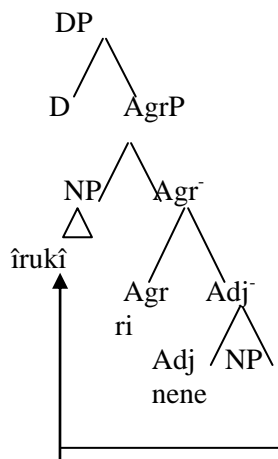

An agreement marker for noun class 5 ‘rî’ is attached to the adjective ‘nene’. It acts as the Probe. The NP ‘îrukî’ acts as the Goal. It is C-commanded by the agreement marker. The Probe shares features for class 5 with the modified noun phrase hence there is agreement.

3.3.4. *The Gîtigania Syntax of Coordinated Modifiers*

It is possible for one to stack several elements to qualify the same noun. According to Cinque (2005) all attested orders of four elements demonstrative, numeral, adjective and noun are derivable from a single, universal order of merge (Dem >Num>Adj> N). Cinque (2005) has established that the hierarchy of nominal projections containing Dem,Num and Adj is as shown in (42).

(42)

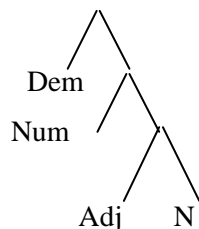

As observed in (42), the Adj modifier is next to the noun. In cases of projections containing Dem, Num and Adj noun modifiers, the hierarchy is as shown in (43).

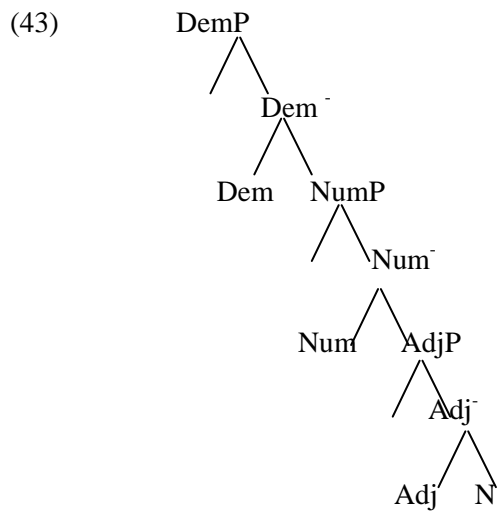

As observed, the noun is the lowest element in the hierarchy. When the noun is found elsewhere, it is through movement.

In regard to the demonstratives, numerals and the adjectives that I have dealt with in this article, the hierarchical ordering is Dem > Num > Adj > N where > indicates C-command. Consider the Gîtigania NP shown in (44).

- (44). Antũ ba ara ba tano banoru
 Person2DemM2 those NumM2 five AdjM2 fat
 ‘Those five fat people’

The derivation of (44) will be as shown in (45).

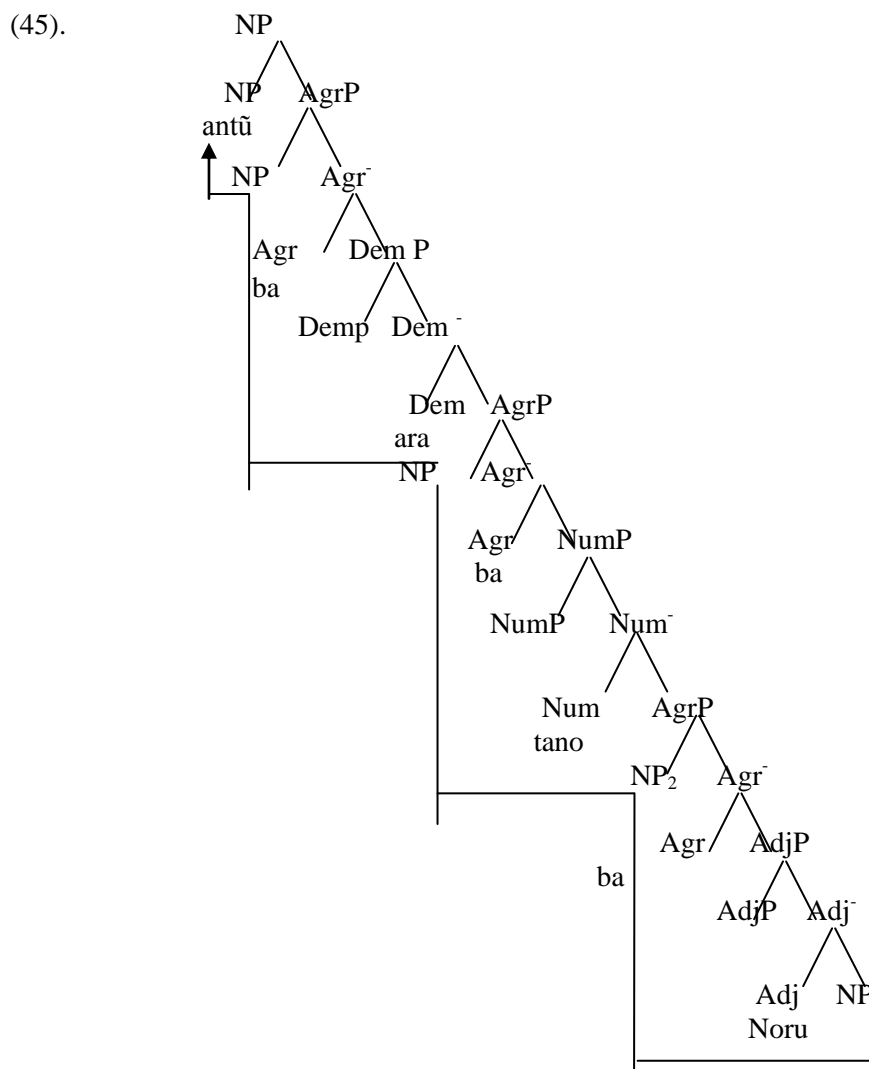

As the Probes, the modifiers (Dem, Num and the Adj) C-command the NP. An agreement morpheme 'ba' for class 2 which is the class of the modified noun phrase is attached to each of the modifiers and matching is established. Therefore, an Agree relation is created between the modifiers and the nouns being modified. According to Lusekelo (2009), the underlying hierarchical order of Dem, NumAdj and N in the extended nominal projection is Dem > Num > Adj > N where > indicates C-command. In (45), the arrow shows the cyclic movement of the NP via spec AgrP1, to spec AgrP 2 then to the spec AgrP3. Noun-modifier Agreement in Gîtigania is therefore seen to subscribe to the Minimalist idea of agree where the heads C-command the NPs that they agree with.

4. SUMMARY OF FINDINGS

This study found out that:

- The phi features on Gîtigania nouns are inherent. They do not require to be deleted. The Probe searches and gets the interpretable features on the Goal and agrees with it. One reflex of this agreement is that the phi features on the Goal are realized on the Probe. In case a Probe fails to agree with the features of the Goal, the derivation crashes.
- In Gîtigania, the visibility of a Goal to a Probe is restricted by locality. The Probe only agrees with the Goal which is closest to it in its C-command domain.
- In the syntax of Gîtigania agreement, the agreement morphemes in syntactic trees C-command the noun phrases that they agree with. In subject-verb agreement, the agreement morpheme attached to the verb C-commands the subject noun phrase. For verb-object agreement, the morpheme for agreement attached to the verb C-commands the object noun phrase whereas for noun-modifier agreement, the agreement morpheme attached to the respective modifiers C-command the noun phrases that they modify.
- In syntactic structures, the Probe and the Goal must meet the conditions of feature matching, C-command and locality.

5. CONCLUSION

In this paper, we have provided a syntactic explanation of agreement in Gîtigania. We have argued that in the syntax of Gîtigania agreement, Chomsky's C-command requirement of Agree can be used to account for agreement. Therefore Gîtigania subscribes to the Minimalist Programme.

REFERENCES

- Abels, K. (2012). *Phases: An Essay on Cyclicity in Syntax*. *Linguistische Arbeiten* 543, de Gruyter, Berlin.
- Adger, D. (2003). *Core Syntax. A Minimalist Approach*. New York: Oxford University Press.
- Baker, K. (2003). *Formal Approaches to Function*. Amsterdam: John Benjamins.
- Borsley, R. (1991). *Syntactic Theory: A Unified Approach*. Great Britain: St. Martin's Press Inc.
- Batlin, M. (2003). The Interaction of Ellipsis and Binding: Implications for the Sequencing of Principal A. *Natural Languages and Linguistic Theory* 21: 215- 246.
- Buell, L. (2005). *Issues in Zulu Verbal Morphosyntax* PhD Dissertation UCLA University of California.
- Chomsky, N. (1981). *Lectures on Government and Binding*. Dordrecht: Foris
- Chomsky, N. (1995). *The Minimalist Program*. Cambridge: MIT Press.
- Chomsky, N. (1998). *Minimalist Inquiries: The Framework*. MIT Occasional Papers in Linguistics.
- Chomsky, N. (2002). *On Nature and Language*. Cambridge: Cambridge University Press.
- Cinque, G. (2005) *Deriving Greenbergs Universal 20 and Its Exceptions*. *Linguistic Inquiry* Massachusetts Institute of Technology. MIT Press.
- Deen, K. (2006). Subject Agreement in Nairobi Swahili. In *Selected Proceedings on the 35th Annual conference of African Linguistics* 225-233, Cascadilla Proceedings Project.
- Dreu, M. (2005). *The Internal Structure of the Zule DP* MA Thesis. Laiden University Press.
- Fosold, R. (2012). *An Introduction to language and Linguistics*. Cambridge University Press: Cambridge.

- Kroeger, P. (2006). *Analyzing Grammar: An Introduction*. Cambridge: Cambridge University Press.
- Lusekelo, A. (2009). The Structure of the Nyakyusa Noun Phrase. PhD Dissertation. Dar es Salaam University: College of Education.
- McCloskey, J. (1991) There, It and Agreement. *Linguistic Inquiry* 22: 563-567. Haegeman (ed)
- Michael, D. (2010). Agreement with Subjects in Lubukusu. PhD Dissertation. Georgetown University.
- Riedel, K. (2009). Object Marking in Sambia. PhD Dissertation. Laiden University.
- Sportiche, D. (1988). A Theory of Floating Quantifiers and its Corollaries for Constituent Structure: *Linguistic Inquiry* 19:425-449.
- Tallerman, M. (2005). *Understanding Syntax*. Chennai: Pvt Ltd.
- Zwart, J. (2006). *Local Agreement*. Amsterdam: John Benjamins.