

The Quantum Nature of Bioenergy

S.I. Konstantinov*

Department of Physical Electronics, Herzen State Pedagogical University of Russia, St. Petersburg, RSC "Energy", Russian Federation.

***Corresponding Author:** S.I. Konstantinov, Department of Physical Electronics, Herzen State Pedagogical University of Russia, St. Petersburg, RSC "Energy", Russian Federation.

Abstract: The article is the first to propose a new approach to describing the macroscopic states of a body through a microscopic quantum description of its state in terms of particles, atoms and molecules and the role of the newly discovered fifth interaction between baryonic matter and dark matter, which forms a quantum vacuum. From these positions, telekinesis and telepathy, the anthropocentric representation of the collapse of the wave function, levitation and pyrokinesis were explained, as well as the aerodynamics of the flight of the May beetle

Keywords: wave function, wave packet, particle, polarization, levitation, pyrokinesis, electron, potential well, oscillation, beetle, helicopter, nozzle, slit

PACS: 01.10.Fv, 04.50.-h, 12.10.Kt, 95.36.+X, 98.80.-k

1. INTRODUCTION

Such mysterious phenomena as levitation, telekinesis (psychokinesis), pyrokinesis, telepathy and clairvoyance have a common quantum nature. At Princeton University in the 70s of the last century, the Princeton Institute of Anomalous Phenomena was opened, which tries to explain the above phenomena from a scientific point of view. True, in addition to empirically obtained methods for the development of these abilities, even American researchers have not made much progress in studying the very mechanism of the phenomenon of anomalous phenomena. As a result of all the experiments done, it was found that anomalous phenomena cannot be directly caused by changes in magnetic, electric, acoustic and thermal fields. Moreover, all these fields, to one degree or another, accompany the phenomenon of telekinesis. Japanese scientists have advanced farthest in recreating telekinesis. In the past 2020, Japanese scientists succeeded in moving objects in three-dimensional space using a sophisticated acoustic levitation system. Thus, the previous record was broken when it was possible to move objects in two-dimensional space. To move small particles of polystyrene between 0.6 and 2 mm in diameter, Japanese scientists at the University of Tokyo and colleagues at the Nagoya Institute of Technology placed the particles inside a complex system of four loudspeaker arrays. Using our own improvements, the existing technology for controlling sound waves, small particles of wood were able to move in the air in all possible boundaries as part of a laboratory experiment. "We were working on advanced acoustic manipulation technology, and as a result, we moved the millimeter particles that levitated in ultrasonic standing waves that were created using ultrasonic phased arrays," the researchers said. Thus, it has been experimentally proven that sound vibrations are capable of moving bodies. However, back in the eighties of the last century, Professor of St. Petersburg State University Aleksey Ivanovich Konstantinov found that in addition to ultrasonic echolocation, dolphins are capable of acoustic manipulations with bodies using ultrasonic signals [1]. Moreover, dolphins are able to communicate telepathically with their relatives congeners over long distances. Numerous experiments and experiments with humans and animals, conducted for more than two centuries, allow us to assert that the nature of anomalous phenomena is due to vibrations in the surrounding quantum environment under the action of a new torsion radiation generated by the fifth interaction between baryonic and non-baryonic matter and similar to gravitational interaction not screened by a baryonic medium [2]. Now the hope of updating the standard model and recognizing the fifth fundamental interaction is with sensational experiments carried out by scientists at CERN and at an accelerator at a science center near Chicago. The new international corporation also includes

physicists from Russia. The researchers were interested in the anomalous magnetic moment of muons, which does not coincide with the calculations of the Standard Model. Professor Mark Lancaster, one of the leaders of the study, said: “We are glad that our data do not agree with the Standard Model, this opens up a future with new laws of physics, new particles and new forces that have never existed before” [3]. Professor Jonathan Feng stated that the fifth interaction does not violate any laws of nature. The new scalar field may belong to a hypothetical dark matter particle - the protophobic X-boson, which, like the Higgs boson, creates a scalar field that is responsible for the fifth interaction between dark matter and ordinary (baryonic) matter. Dr. Jonathan Feng of the University of California, Irvine said in a 2017 press release: “For decades, we have known about four fundamental forces: gravity, electromagnetism, and strong and weak nuclear forces. The discovery of a possible fifth force acting between baryonic and dark matter will completely change our understanding of the universe, which will entail the unification of the fifth force and dark matter. The protophobic X-boson of dark matter makes it possible to explain a number of experiments in which the anomalous magnetic moment of the muon associated with the fifth interaction is observed” [4].

2. ANTHROPOCENTRIC REPRESENTATION IN QUANTUM THEORY

The study was based on an experiment quite familiar to physicists. With the help of a laser, they shine on the screen of the photodetector. There is another screen with two small slits between the light source and the photodetector. As a result, the photodetector captures the characteristic striped pattern that results from the interference of waves passing through two small slits. This is a classic experiment in quantum physics. Now imagine a picture: an ordinary person was seated two meters from the laser and asked to think about this device. It's not even easy to think, but to wish that the distribution of photons deviated from the theoretical one. The experiments of Dean Reidin and others show that a person sitting two meters away influences the distribution of photons by thinking about them. Dark stripes become slightly lighter, light stripes slightly darker. The experiment was carried out for several years on dozens of volunteers. Then a series of experiments was carried out with single quantum particles. As a result of the experiment, wave interference is obtained, as if an electron flew simultaneously through two slits, and a probability field arises - the same striped grid on a photodetector (Figure 1. Young's experiment)

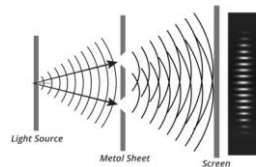

Figure1. *Thomas Jung - Double Slit Experiment*

In numerous experiments with quantum particles, it has been irrefutably proven that a person's thought influenced the probability distribution, in other words, the pattern that was obtained when the experiment was repeated many times. This phenomenon was called mind matter interaction (MMI) - the influence of mind on matter. Not only everyday experience, but also the dominant physical paradigm speaks of the impossibility of such a phenomenon. However, within the framework of Lev Sapogin's Unitary Quantum Theory [5] and the polarization model of the quantum vacuum [6], Dean Reidin's experiments find an explanation. Consider an extremely simple single particle experiment within the framework of modern quantum theory. Let a single photon fall on a semitransparent mirror placed at an angle of 45 degrees to the stream. Semi-transparent means that half of the incident light is reflected and the other half is transmitted. Photon counters are installed in reflected and transmitted beams. Within the framework of the wave theory, everything is simple: the incident wave will be partially reflected, and part of it will pass. But the particles, if they are indivisible, must either pass or be reflected. If the reflected particle counter registers it, then the second counter registers nothing. But in fact, if you combine the transmitted and reflected rays and send them to the screen in accordance with the wave theory, interference will be observed, although from a corpuscular point of view, this should not be. In fact, interference occurs even for single particles. From the point of view of the UQT, the wave packet (particle) will split on the mirror, and a part of it will enter each beam, and this depends on the phase of the packet at the mirror and its structure at this place. We will get, in general terms, two unequal packet fragments with lower amplitudes, which can create an interference pattern. The change in the frequency of the fragments will not follow, since all processes are linear, that is, they do not depend on the amplitude. The probabilities of detecting fragments will decrease, since a

large vacuum fluctuation is required to exceed the counter detection threshold. Therefore, as a result of measurements, a single particle can be lost or observed in both beams at the same time. The appearance of two particles from one should not be embarrassing, since the energy of the fragments will be restored to a full particle by superimposing vacuum fluctuations. The assertion of Quantum Mechanics that a particle can be in different places at the same time has been counterintuitive for decades with no explanation. Within the framework of the UQT, now all this is correct in principle, and, most importantly, it is now clear how all this happens [5]. Corpuscular properties arise due to the localization of the wave packet in a small spatial region. The appearance of a diffraction pattern from de Broglie waves is explained as follows: when a wave packet approaches a screen with two slits (Young's experiment), its fragmentation occurs, and we will observe the usual diffraction of partial waves on the screen [5]. From the standpoint of the quantum field, the quantum vacuum is a complex quantum, dynamic object that manifests itself at the microscopic level through its fluctuations. In this case, a number of components of the quantum physical vacuum are investigated, such as gluon condensate, quark condensate, local field fluctuations in the production of electron-positron pairs [7]. Today physicists say that instead of studying empty space, they can create a Bose-Einstein condensate to study the quantum vacuum and dark matter [7]. The collapse of the wave function in quantum theory cannot be described using the Diosi – Penrose model [8]. The reason is that the creation of particles leads to a violation of symmetry in time, and the invariant equations of the general theory of relativity (GR) of Albert Einstein, which underlie the Standard Model, do not allow this. As was proved by the Nobel Prize Laureate Professor I. Prigogine, in this case it is impossible to use Einstein's invariant equations of general relativity [9]. In the new physics, the recognition of the quantum vacuum (dark matter) in the theories of quantum electrodynamics (QED) and quantum chromodynamics (QCD) leads to the violation of symmetries, conservation laws and prohibitions of the Standard Model [10]. Experiments show that if an external field acts on a vacuum, then due to its energy the creation of real particles is possible [11]. Precisely because the vacuum is not virtual, but a real physical object (dark matter) and has a structure, the polarization of the vacuum leads not to virtual, but to real radiative corrections to the laws of quantum electrodynamics. In this case, the vacuum becomes unstable, that is, fluctuations are observed in it [11]. Since the thought process is accompanied by spin currents and the formation of vortex torsion fields, the transmission of thought over a distance is carried out by non-screened torsion vortices, the energy of which can cause polarization of the quantum vacuum, the influence of the observer can be transmitted over long distances [12]. A famous representative of the “anthropic principle”, in which the observer is the key to the existence of the process of collapse of the wave function, is the physicist John Wheeler, who argued that in reality particles appear only when the researcher observes them. In Cosmic Search Magazine, bringing the idea of the anthropic principle to the Absolute (God), he stated: “We cannot even imagine a Universe that, somewhere and for a certain period of time, would not contain observers, because the Universe itself is this act observer ...”. Renowned molecular geneticist Jonjo McFadden, who is leading the new study, believes that consciousness is an energy field formed from the field of electromagnetic waves that neurons emit when they are active (Fig. 2) [13].



Figure2. *EM field of the brain.*

Thus, the observer's thought affects the probability distribution of the collapse of the wave function of particles, in other words, the pattern, indirectly, through the polarization of the vacuum that causes its fluctuation.

3. THE MICROSCOPIC LEVEL OF DESCRIBING FLUCTUATIONS IN TERMS OF ELEMENTARY PARTICLES AND ATOMS AND THE MACROSCOPIC LEVEL OF DESCRIBING THE EFFECTS OF LEVITATION AND PYROKINESIS

Historically reliable facts testify to the levitation of the Italian monk Giuseppe Des (1603-1663) and the nun Avila Sister Teresa (1520-1580). Falling into religious ecstasy, both of them repeatedly,

against their will, detached themselves from the Earth and hovered at a height of several meters and higher. At the same time, their bodies vibrated with a certain frequency, representing an analogue of a physical oscillator. In Tibet, the founders of the practice of levitation were the monks of the Shaolin monastery. In India and Tibet, the art of levitation has survived to this day. Currently, the greatest results in the field of levitation have been achieved by those who use the yogic technique. To solve the problem of human levitation and pyrokinesis, let us consider the approaches of the Unitary Quantum Theory of Professor Lev Sapogin to the description of elementary particles and atoms. Let us turn to the behavior of electrons in a potential well in the theory of Lev Sapogin [5]. In the UKT, the equation with an oscillating charge is essentially Newton's equation for the movement of a charge in an external potential, but the magnitude of the charge depends on time, velocity and coordinates [5]. When solving the problem of a harmonic oscillator, in addition to the usual stationary solutions, 2 more new solutions appear (Fig. 3), which were named Crematorium and Maternity Home. In the first solution, the particle oscillates in a potential well with an exponential decrease in energy, and in the second solution, its energy increases (for a parabolic well, it is unlimited).

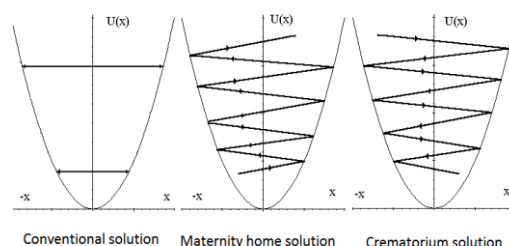

Figure2. *UQT solutions for particle oscillations in a potential well*

The autonomous movement equation in the case of a potential well in the shape of hyperbolic secant $U(x) = -U_0 \operatorname{sech}(x^2)$ will look as follows:

$$m \frac{d^2x}{dt^2} + \frac{4U_0 Q x \cos^2\left(-mx \frac{dx}{dt} + \varphi_0\right) \sinh(x^2)}{\cosh^2(x^2)} = 0 \quad (1)$$

where x is the coordinate of the particle as a function of time;

m, Q, φ_0 is mass, charge and initial phase of the particle.

It turns out that the nature of the trajectory of a particle under the same initial conditions depends very strongly on the initial phase [5].

At $\varphi_0 = 0.1$, the particle rolls into the hole and is reflected with greater energy. Under the same initial conditions and at $\varphi_0 = 0.2$, an oscillation of a particle in the well with almost the same energy is observed, and at $\varphi_0 = 3.2$, an increase in oscillations inside the well (Maternity Home) is observed up to an energy sufficient to exit the well [5]. Where does the electron in the potential well get additional energy from, thereby violating the law of conservation of energy? The energy source is the fifth fundamental interaction between baryonic and non-baryonic matter. Nobel Prize laureate I. Prigogine, studying the dynamics of systems development and, in particular, the growth of entropy, found that “in a steady state, the active influence from the outside on the system is insignificant, but it can be of great importance when the system goes into a nonequilibrium state. In this case, the system becomes non-integrable, time loses its invariance and its behavior is probabilistic” [9]. The dynamics of the bodies of monks hovering over the Earth, whose cells vibrate into resonance like a large resonator in a gravitational field, can be explained from the standpoint of the Unitary Quantum Theory, when fluctuations were first localized in a small part of the system (electrons and atoms), then spread to the entire body of a monk and brought him into a new macroscopic state. Traditional continuum mechanics, which postulates a symmetric stress tensor, is applicable only to processes without an internal moment distribution, when the moment equations are satisfied identically. At the same time, internal moments can arise in a polarization medium under the action of a magnetic field, which create shear stresses with an asymmetric tensor. Consider the Einstein-de Haas experiment, which demonstrates the rotation of a ferromagnet placed in a constant magnetic field. This effect is explained by the fact that the spins of ferromagnets initially oriented in an arbitrary way, under the action of a magnetic field, acquire a predominant orientation in the direction of the field. And if in the initial state, the total angular momentum of all spins was equal to zero, then in a magnetic field it

acquired some value. According to the theorem on the angular momentum, this will lead to the rotation of the crystal lattice in the direction opposite to the spins. In addition, the internal moment of the spins causes a shear stress, leading to torsional deformation of the ferromagnet. This experience clearly shows how microscopic processes, studied only by quantum mechanics, manifest themselves in macroscopic processes. This situation radically changes the traditional concepts of a microscopic description of a state in terms of particles, atoms and molecules, and a macroscopic description in terms of concentrations, densities and volumes.

For oscillations of mechanical oscillators, when the body mass m performs harmonic oscillations under the action of a periodic force, Professor A. Dmitriev proposed a formula for determining the weight of the oscillator P , averaged over the oscillation period [14]:

$$P = mg_0 \left[1 - (\alpha_p - \alpha_c) \frac{A\omega^2}{\pi g_0} \right] \quad (2)$$

Where:

g_0 is acceleration of gravity

A is amplitude,

ω is circular vibration frequency,

In formula (2), the dimensionless coefficients α_v and α_r characterize the degree of influence of external non-gravitational, for example, elastic, forces on the force of gravity. The question of whether these coefficients are nonzero and what their numerical values are equal to can only be solved experimentally. The estimate of the difference between the interaction coefficients $\alpha_r - \alpha_v$ made by Professor Dmitriev turned out to be close in order of magnitude to 10^{-7} [14]. The quadratic dependence of P on ω in formula (2) indicates that the effect of the acceleration of external forces on the body weight should be significant at high, for example, ultrasonic, body vibration frequencies [14]. Using formula (2), it is possible from simple quantum relations to find the frequency and de Broglie wavelength for lifting a body weighing 70 kg to a height of 1m

$$v = W / h \text{ or } \omega = W / \hbar \text{ and } \lambda = 2\pi s / \omega \quad (3)$$

where W is the energy of the oscillating body, $W = 70J$

h - Planck's constant $h = 6.6260 \cdot 10^{-34} \text{ J / Hz}$

$\hbar = h / (2\pi) \hbar = 1.0546 \cdot 10^{-34} \text{ J / Hz}$

s - speed of light $s = 299792458 \text{ m / s}$

In levitation, we take the body weight $P = 0$, then the value of the cyclic vibration frequency of the body in order of magnitude turned out to be close to 10^{11} Hz . This is the so-called Schrödinger jitter frequency ("zitterbewegung"). In the UQT of Professor Lev Sapogin, this frequency of the wave packet, at resonance, is equal to the de Broglie frequency [5].

Pyrokinesis, similar to levitation, is also associated with the uncontrolled absorption of energy by the cells of the body when implementing the Maternity Home UKT solution from the surrounding quantum vacuum, which can lead to spontaneous combustion. A person's body is completely burned up, while his clothes remain untouched by fire. This indicates that the energy is generated by the cells of the body themselves. A similar effect is observed in any baryonic matter, for example, in the amazing experiments of A. Samgin and A. Baraboshkin (Russia) [15] and T. Mizuno (Japan) [16]. They used, independently of each other, special proton-conducting ceramics, which are capable of generating thermal energy thousands of times more than the energy through which an electric current passes. In some experiments T. Mizuno this value exceeded 70,000. However, radiation or nuclear fragments were not detected, and nuclear processes are not responsible for such a release of energy. Such proton-conducting (more precisely, deuterium-conducting) ceramics were created by powder metallurgy by sintering at a high temperature. In other words, all chemical processes in it have passed long ago. The origin of such an amount of excess energy in the framework of ordinary science is completely incomprehensible, since it cannot be explained by either nuclear or chemical reactions, or phase transitions. The authors of this experiment assumed that there were $D + D$ nuclear fusion

reactions. After releasing such a large amount of energy, the tablet disintegrates into powder. Something similar is observed in Andrea Rossi's E-Cat reactor. The reactor is a ceramic tube in which nickel powder is placed under pressure with hydrogen (Figure 4).

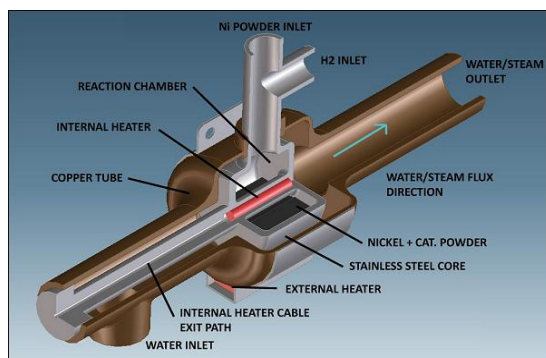
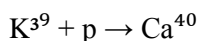
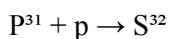
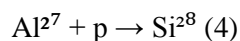
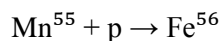

Figure4. Andrea Rossi E-Cat Reactor

In the presence of electric current, the system heats up and generates 3-50 times more heat than it consumes. The question arises of cold nuclear fusion as a source of energy in all of the above cases, including pyrokinesis [17]. It was discovered long ago that nuclear transmutations are widespread (this is especially noticeable for plants and biological objects), but they are weakly associated with the release of energy. Examples of such reactions:



In reactions of this type, a very slow proton (its kinetic energy is practically zero) penetrates into the nucleus in the way indicated above and remains there. There is no release of nuclear energy because the nucleus remains stable both before and after the reaction. According to classical nuclear physics, the nucleus, as usual, after being hit by a charged proton with high kinetic energy, becomes unstable and disintegrates into parts, and its fragments receive high kinetic energy. Reactions of this type were generally considered impossible at low energies and therefore were not studied in classical nuclear physics. Apparently, this is a completely new type of nuclear transformations, not recognized by modern nuclear science, but discovered experimentally a long time ago. Today, there is a lot of experimental data confirming the massive nature of nuclear transmutation [18]. The nature of pyrokinesis is also due to such transmutations, the energy for which is drawn from the surrounding quantum environment.

4. FEATURES OF AERODYNAMICS OF FLIGHT OF THE BEETLE

According to the laws of modern physics and aerodynamics, the beetle should not fly. The wing area is too small in relation to the body weight of the insect itself. In order to fly, the May beetle, with an average mass of 9 g, must have a lift coefficient of 2 to 3. In fact, this insect has a lift coefficient of less than one! The flight of the beetle (Figure 5) has been the topic of special research.



Figure5. May beetle in flight

Here is the conclusion to which the head of these studies, American scientist Leon Bennett, came: "If we can determine the aerodynamics of the flight of the May beetle, we will either discover some imperfection of the modern theory of insect flight, or we will discover that the May beetle has some

unknown way of creating high lift ". In France, in one of the design bureaus there is a framed photograph of the May beetle, under which it is written: "The May beetle flies, violating all the laws of aerodynamics, but he does not know about it and continues to fly." Scientists do not yet know why the beetle flies. To solve this puzzle, we need to turn to the basics of gas dynamics and in particular to the definition of jet engine thrust. As you know, the thrust of a jet engine is equal to:

$$F = G(u-V) + S(P-p) \quad (5)$$

Where F is the thrust of the nozzle;

G is the mass flow rate of the gas;

U is the gas flow rate;

V is the speed of the aircraft;

S is the cross section of the nozzle;

P is the absolute pressure at the nozzle exit;

P is atmospheric pressure.

The first term in this equation is "reactive force", which includes the mass flow rate of the gas. The second term does not include the gas flow rate, but the gas flow rate is required for the differential pressure to occur and therefore for the difference (P-p). It is beneficial when the first term is small and the second is large. This creates conditions for low gas consumption and at the same time high thrust. A group of engineers NPO im. Lavochkin, headed by Professor Yu.I. Volodko tested more than 50 nozzles, each of which was a flat slit with gaps from 8 to 130 mcr. [nineteen]. The length of the path of the passed air was in the range of 0.2 - 62 mm. For all nozzles, the gap of the slit was chosen much less (75 - 1600 times) than the width of the slit B, and the length of the air path in the slit L was 2 - 1200 times larger than its gap. The calculated criterion was 100m / s, which indicated the laminar nature of the flow. If the thrust of the nozzle is divided by the cross-section of a narrow internal channel, then the obtained value has the dimension of pressure and can be called "effective pressure". Surprisingly, as experiments have shown, it is 2-4 times higher than the pressure in the receiver at the inlet. And this is equivalent to an increase in the speed of molecules, since the pressure is the sum of the impacts of individual molecules and the higher the speed of the molecules, the greater the pressure. Thus, it turned out that the kinetic energy is 2 or more times higher than the energy spent on air compression. This remains inexplicable for modern gas dynamics and leads to a significant increase in excess pressure [19]. However, in terms of new discoveries in quantum dynamics and the recognition of the fifth interaction, in which additional energy for baryonic air molecules is drawn from the surrounding quantum vacuum, the new gas dynamics easily explains the mystery.

The peculiarities of the wing structure of the May beetle and the dynamics of its flight allow it to draw additional energy from the environment. When the wing of the beetle moves downward, a lifting force is created and, in addition to it, due to some rotation of the wing, a traction force (pushing force) is also created. In this case, air is also sucked into the space between the elytra and the wing. At bottom dead center, the wing of the beetle unfolds and changes the angle of attack. The wing now displaces air from under the elytrum when moving up. Moreover, the resulting jet of air creates both a lifting force and a thrust force, since this jet is directed at an angle downward and backward. Thus, it turns out that the May beetle combined flapping and jet flight. For the May beetle, it was possible to find only the measured Flapping wing in the hover mode, it turned out to be 0.6 with a beetle weight of 0.059 N, and the Reynolds number (Re) for the wing along the chord turned out to be large $Re = 4700$ [20]. This is not surprising, since the relationship between frictional resistance and pressure resistance depends on the Reynolds number. In a non-equilibrium state of the system, vortices arise behind the body. At the same time, the energy of the vortices actively affects the system "from the outside" (from the environment). The pressure in the vortex zone formed behind the body will be reduced, therefore the resultant of the pressure forces will be different from zero, determining, in turn, the drag. As a result, drag is a combination of frictional resistance and pressure resistance. The more Re, the greater the role of pressure resistance. An increase in frontal resistance will counteract a change in the state of the system, i.e. generate an additional field of inertia, which becomes stronger, the greater the disturbance is on the environment. Thus, the May beetle, hanging around a green leaf that serves as its food, draws most of its energy from the environment.

Today, engineers, without waiting for new quantum aerodynamics, are using the beetle effect to create fundamentally new aircraft, in which the fuel is used many times more efficiently than in helicopters.

New helicopters can hover for a long time at the desired point in the airspace, practically consuming no fuel.

5. CONCLUSION

In my article, I highlighted only a small part of anomalous phenomena, the physical nature of which is associated with new discoveries in quantum bioenergy, but these discoveries allow scientists and engineers to take a fresh look at previous scientific achievements and adopt a new scientific paradigm.

REFERENCES

- [1] A.I. Konstantinov, V.N. Movchan "Sounds in the life of animals", Leningrad, Leningrad University Publishing House, (1985)
- [2] A.E. Akimov, V. Ya. Tarasenko "Models of polarized states of physical vacuum and torsion fields", *Russian Physics*, N3, 13-23 pp., (1992)
- [3] Yu. M. Andreev et al. "Constraints on new physics in electron g-2 from a search for invisible decays of a scalar, pseudoscalar, vector, and axial vector", *Phys. Rev. Lett*, Accepted 16 April 2021
- [4] Feng Jonathan L., "Protophobic Fifth Force Interpretation of the Observed Anomaly in ^8Be Nuclear Transitions", arXiv: 1604.07411v2 [hep-ph], (15 Aug. 2016)
- [5] Leo G. Sapogin, Yu.A Ryabov, V.A. Boichenko, "The Unitary Quantum Theory and a New Sources of Energy". - Science Publishing Group, USA. (2015)
- [6] Stanislav Konstantinov, "The Role of Vacuum Polarization in the Large Hadron Collider", *Global Journals Inc. (USA) GJSFR-A*, Volume 20, Issue 4, Version 1.0, pp 21-27, (2020)
- [7] S. Autti, et al., "Fundamental dissipation due to bound fermions in the zero-temperature limit" *Nature Communications* volume 11, Article number: 4742 (2020)
- [8] Roger Penrose, "Quantum State Reduction", - *Found Phys* (2014) 44:557–575, DOI 10.1007/s10701-013-9770-0
- [9] Prigogine I.R., Stengers I., "Time, chaos, quantum", Moscow: Progress, 1994
- [10] S.I. Konstantinov, "Roger Penrose and Black Holes", *International Journal of Advanced Research in Physical Science (IJARPS)*, Volume 8, Issue 1, (2021)
- [11] Konstantinov Stanislav, "Polarization of Vacuum", *Open Access Journal of Physics*, Volume 2, Issue 3, pp. 15-24, (2018)
- [12] Boldyreva L.B. "What does physics granting physical vacuum properties of superfluid $^3\text{He-B}$ " Moscow: URSS, 2011.
- [13] John Joe McFadden, "Integrating information in the brain's EM field: the cemi field theory of consciousness", *Neuroscience of Consciousness*, Volume 2020, Issue 1, 2020
- [14] Dmitriev A.L. "Experimental gravity" - St. Petersburg: Renome (2014).
- [15] Samgin A., Baraboshkin A. et al. The influence of conductivity on neutron generation process in proton conducting solid electrolytes, - In: *Proceedings of the 4th International Conference on Cold Fusion*. Palo Alto, USA, v.3, p.51-57. (1994)
- [16] Mizuno T., Enio M., Akimoto T. and K. Azumi Anomalous heat evolution from SrCeO₃-type proton conductors during absorption/desorption of deuterium in alternate electric field, - *Proceedings of the 4th International Conference on Cold Fusion*, December 6-9, 1993, Hawaii, vol.2, p.14., EPRI, Palo Alto, USA. (1994)
- [17] Leo G. Sapogin, Vladimir A. Dzhaniybekov, Yuri A. Ryabov "Enigmatic E-Cat of Andrea Rossi and the Unitary Quantum Theory", *Open Access Library Journal*, Vol.3, No.7, (July 2016)
- [18] Stanislav Konstantinov, "Nuclear fusion: the management prospects", *Physics & Astronomy International Journal*, Volume 2 Issue 6 (2018), pp. 537-545
- [19] Volodko Yu.I. Laminar discharge of compressed air into the atmosphere and a fuel-free monothermal engine, - M.: "Public benefit" 1998 *Scientific journal ZhRFM* No. 1-12, 1998
- [20] Alexander P. Biomechanics. - M.: Mir, 1970

Citation: S.I. Konstantinov (2021). *The Quantum Nature of Bioenergy. International Journal of Advanced Research in Physical Science (IJARPS)* 8(6), pp.13-20, 2021.

Copyright: © 2021 Authors, This is an open-access article distributed under the terms of the Creative Commons Attribution License, which permits unrestricted use, distribution, and reproduction in any medium, provided the original author and source are credited.